



COMPLEX SOLUTIONS OF MATERIAL TESTS

K. Frydryšek, J. Fuxa, M. Fusek¹

Summary: *This article is focused on the computational and experimental solution of the material tests and their evaluations (constitutive equations etc.). Problem deals with torsion tests and other kind of tests. The results acquired by FEM (MSc.MARC/MENTAT and ANSYS software) are compared with experiments. This article also describes some experimental machines developed at the Department of Mechanics of Materials at the VŠB-Technical University of Ostrava and controlled by LabVIEW software.*

1. Introduction

This article shows some examples of complex solutions of material tests in the field of large plastic deformations and in the field of low-cycle fatigue of materials. The term “complex solutions” means numerical and experimental solution.

2. Examples of Torsion Material Tests (FEM Solutions Compared with Experiments)

References [1] to [8] describe in detail the new original torsion test evaluation method and its refinement, for a quasi-static and proportionally loaded symmetric specimen, vide fig.1. This method holds for elasto-plastic domain. The material equation acquired from experimental measurements for steel 14109 (ČSN 420074). The limiting surface of plasticity was determined from equation by the von Mises yield criterion with isotropic hardening rule.

Figures 2 and 3 show two different FE models created and solved in MSc.MARC/MENTAT and ANSYS software.

¹ Ing. Karel FRYDRÝŠEK, Ph.D., ING-PAED IGIP; prof. Ing. Jan FUXA, CSc.; Ing. Martin FUSEK; Katedra pružnosti a pevnosti FS VŠB-TU Ostrava; Třída 17. listopadu 15; 708 33; Ostrava-Poruba; tel.: 597324552, 597324412; e-mail: karel.frydrysek@vsb.cz; jan.fuxa@vsb.cz; martin.fusek@vsb.cz; fax.: 596916490.

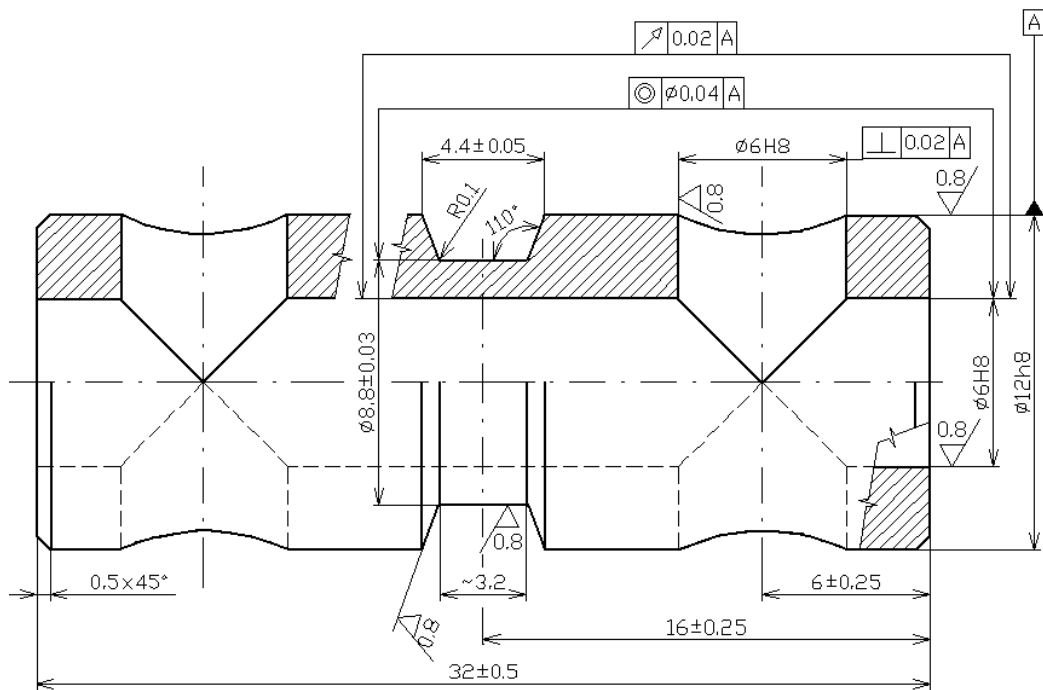

Fig.1 An enlarged manufacturing diagram of the laboratory short specimen from steel.

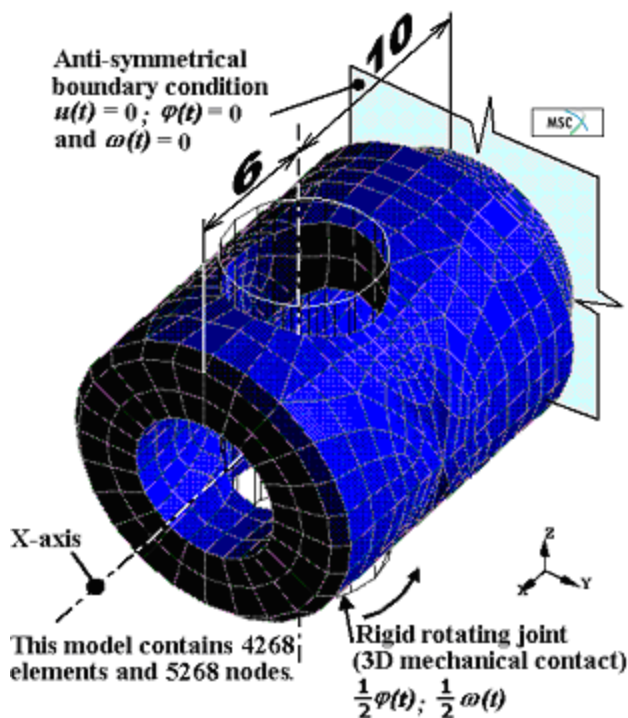

Fig.2 FE Model for Torsion (MSc.MARC/MENTAT Software).

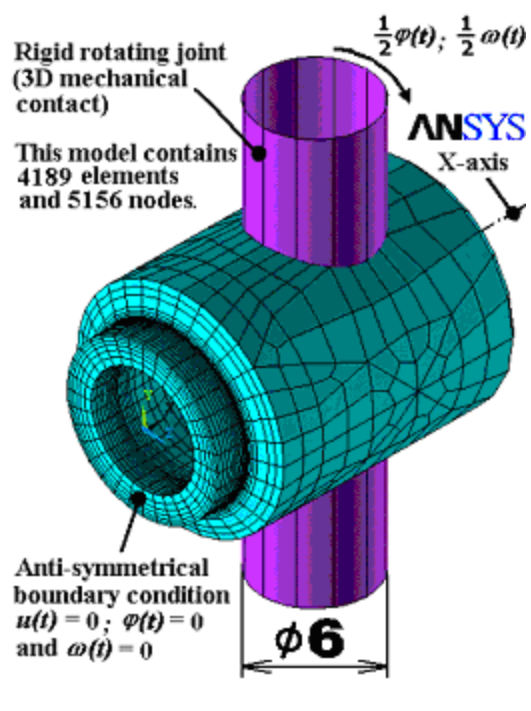

Fig.3 FE Model for Torsion (ANSYS Software).

A geometrical planar anti-symmetry was successfully used for FE mesh modelling in the cylindrical co-ordinate system in plane symmetry YZ (displacement $u(t) = 0$, angle of rotation $\varphi(t) = 0$ and angular velocity $\omega(t) = 0$). As an external time dependent condition, one half of

the angular velocity $\omega = \omega(t)$ (rotating around rotation axis X) was applied to the joint of the specimen. This angular velocity was acquired from experiments and correlates with the dynamical starting effects of a torsion plastometer. For more information see [1] to [8].

The fixation of the specimen in the joints is approximated to a case of 3D mechanical contact between the joints and holes of the specimen. The above-mentioned arguments of plane symmetry are sufficient to modelling only one joint, which can be considered as a rigid (undeformed) body. But one half of the specimen, along with a contact hole, is a deformed body. The influence of a Coulomb friction was applied between the joint and hole.

The solution was found at time period $t \in \langle 0 ; 0.05 \rangle s$ subdivided into 144 intervals of various sizes. Large strain rate velocities (the sudden fracture of a plasticity cross-section reached in a short time) were considered during the solution. The tensor of elastic and plastic strains was used in the whole plasticity time solution history.

The comparisons of all mentioned FEM approaches with experiments are shown in fig.4 and 5. The main credibility criterions of the FEM (MARC/MENTAT and ANSYS) packages are the determined values of torque $M_k [Nmm]$ dependent on time t. These relations are compared with experimental values in fig.4 (for MSC.MARC/MENTAT software) and fig.5 (for ANSYS software).

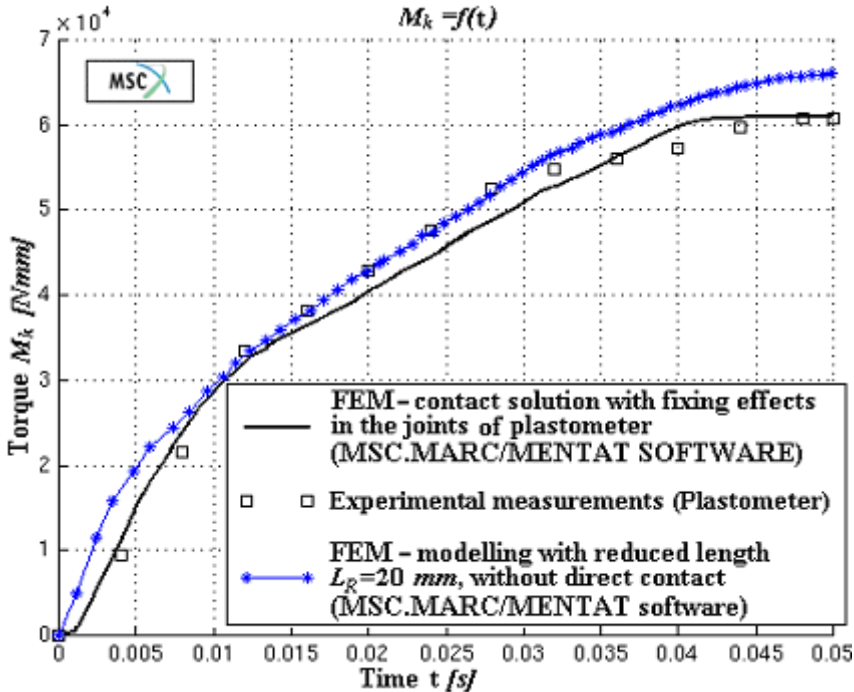

Fig.4 Comparison of time-torque dependencies in the whole torsion test process (evaluated from experiments and FEM simulations by MSC.MARC/MENTAT software).

Thus from the given information it is clear that the MSC.MARC/MENTAT and ANSYS computations give us satisfactory solutions

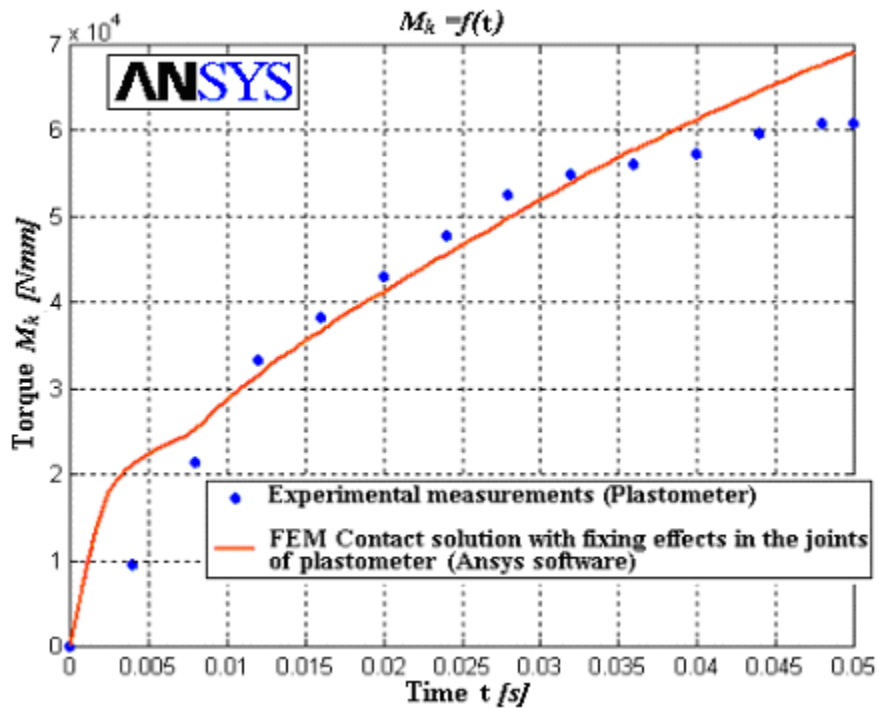

Fig.5 Comparison of Time-Torque Dependencies in the Whole Torsion Test Process (Evaluated from Experiments and FEM Simulations by ANSYS Software).

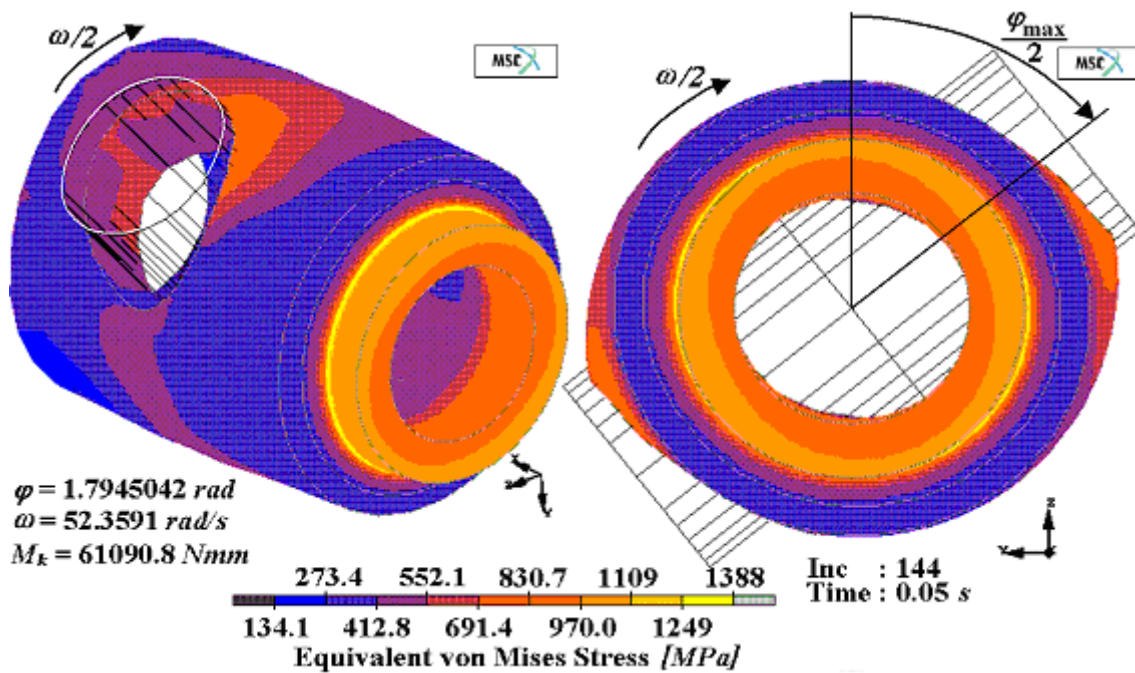

Fig.6 The Values of S_σ at Time $t = 5 \times 10^{-2} \text{ s}$ (Torsion Tests - MSc.MARC/MENTAT Software).

The distribution of stress intensity at time $t = 5 \times 10^{-2} s$ is visualised in fig.6 (software MSC.MARC/MENTAT) and fig.7 (software ANSYS). The maximum values ($S_{\sigma} = 1388 MPa$, Fig.6) or ($S_{\sigma} = 1406 MPa$, Fig.7) are in the neck notch radii ($R=0.1 mm$) of the specimen. Figure 6 and 7 show non-uniform stress distributions through the neck cross-section in symmetry plain YZ. They also show the shape buckling due to excessive plastic strains and also the material accumulation in the contact locality of joint.

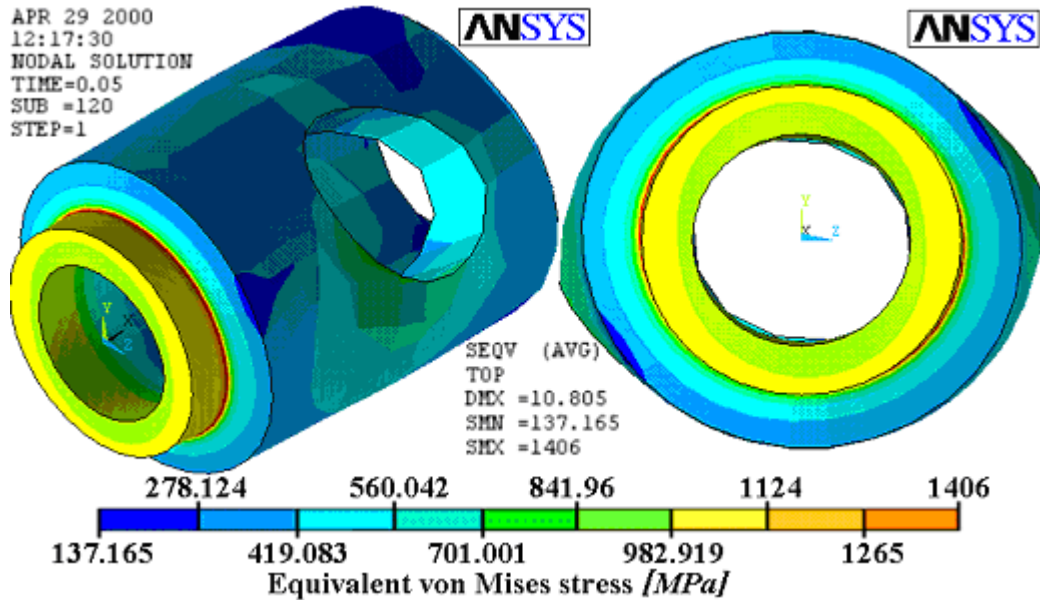

Fig.7 The Values of S_{σ} at Time $t = 5 \times 10^{-2} s$ (Torsion Tests - ANSYS software).

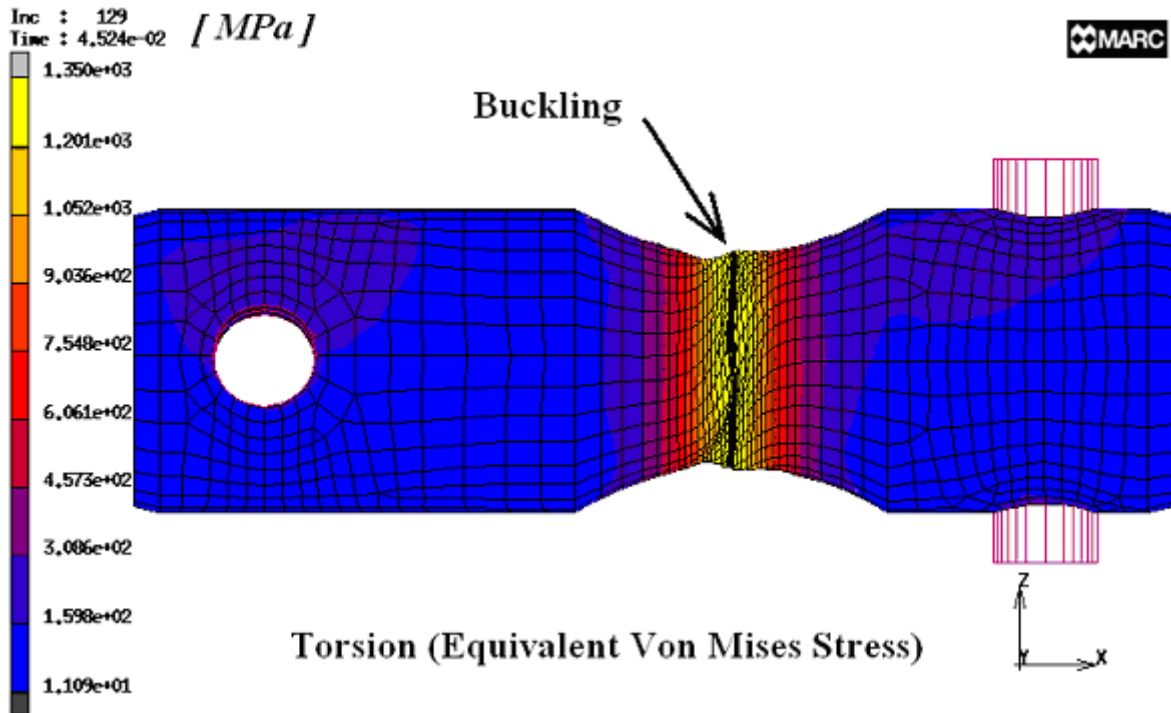

Fig.8 The Values of S_{σ} at Time $t = 4.524 \times 10^{-2} s$ (Torsion Tests – MSc.MARC/MENTAT software).

3. Example of Other Kind of Material Tests

On the figure 8 is shown other kind of material tests (torsion of special specimen) with buckling effects, for more detail see [1].

4. The Realisation of Test Machine for the Research of Contact Fatigue

The test machine for the research of contact fatigue as a complement of the servo-hydraulic machine INOVA 200kN is shown in fig.9. This machine was proposed and realised in the department of mechanics of Materials at VSB – Technical University of Ostrava.

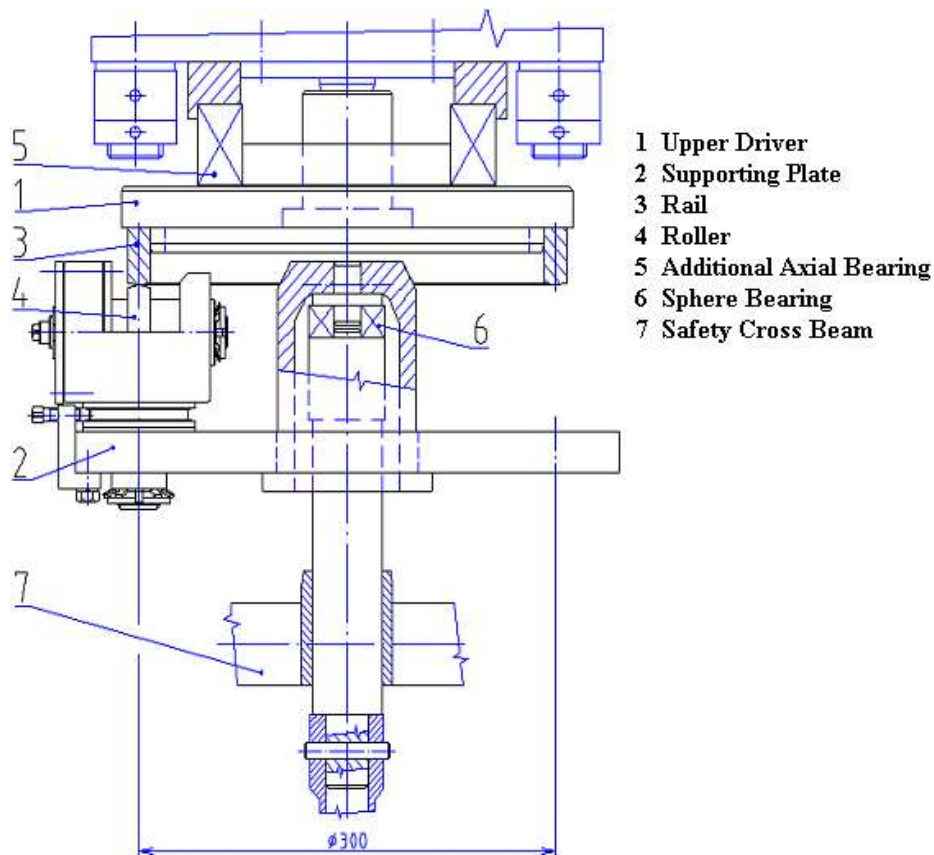

Fig.9 Diagram of the Machine for Contact Fatigue Tests.

This machine will be used:

1. for the solution of quantitative coherence between number of cycles to the origin of fatigue cracks in microstructures of different materials by contact fatigue and number of cycles.
2. for initiation of crack by combination of tensile and pressure stresses in the area of the fatigue of materials.
3. The experimental results will be also important for future numerical solutions.

This machine is controlled by applications created in LabVIEW software, vide Fig.10. For more details see [9] to [12].

This work was supported by GAČR 101/04/0475.

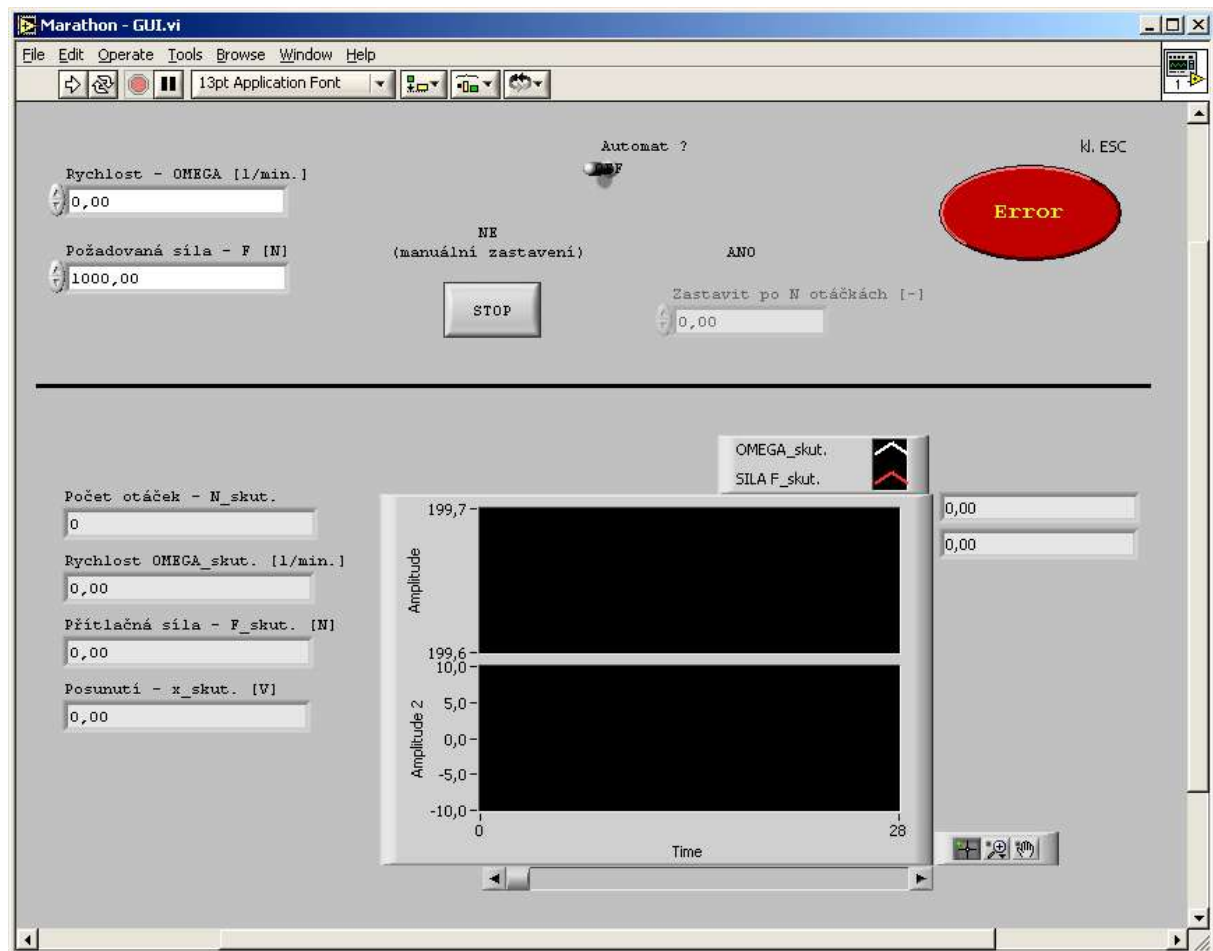

Fig.10 View of Front Control Panel Created in LabVIEW Software.

5. Literatura

- [1] Frydrýšek, K.: Modelování deformačních a napět'ových stavů ve zkušebních vzorcích při materiálových zkouškách prováděných jednoduchými i kombinovanými zátěžnými stavy, (*disertační práce v oboru „Aplikovaná mechanika“*), FS VŠB-TU Ostrava, 1999.
- [2] Frydrýšek, K.: The Torsion Test Simulating for short specimens, *In: „Sborník vědeckých prací Vysoké školy báňské –Technické univerzity Ostrava“*, řada strojní, no. 1, vol. XLV, 1999, ISBN 80-7078-723-6, ISSN 1210-0471, p. 87-91.
- [3] Frydrýšek, K.: Torsion Test FEM Modelling for a Short Specimen, *In: Sborník „37. mezinárodní konference Experimentální analýza napětí - EAN 99“ - Frenštát pod Radhoštěm*, VŠB-TU Ostrava, 1999, ISBN 80-7078-672-8, s. 29-32.

- [4] Frydrýšek, K., Fuxa, J.: Numerické a experimentální řešení napětově deformačních stavů při kroucení, *In: Sborník „38. mezinárodní konference EAN 2000- Třešt“*, VÚT Brno, Fakulta strojní, 2000, ISBN 80-214-1569-X, s. 75-81.
- [5] Fusek, M., Frydrýšek, K.: The Torsion Test Simulating for short specimens – Part 2, *In: „Sborník vědeckých prací Vysoké školy Báňské – Technické univerzity Ostrava“*, číslo 1, řada strojní, vol XLVI, 2000, ISBN 80-7078-875-5, s. 73-78.
- [6] Fuxa, J.: Příspěvek ke kvantitativnímu určení mezních stavů proporcionálně zatěžovaných materiálů, kandidátská disertační práce, VÚHŽ Dobruška, únor 1986.
- [7] Fuxa, J.: Metoda vyhodnocení torzního testu, *In: Sborník vědeckých prací VŠB-TU Ostrava*, číslo 2, rok 1994, ročník XL, řada strojní, p. 51-62.
- [8] Fuxa, J.: Výzkum kritérií pevnosti kvaziizotropních materiálů namáhaných monotónně rostoucími složkami víceosého napětového stavu, Závěrečná zpráva GAČR, registrační číslo 101/96/1477, VŠB-TU Ostrava, 1998.
- [9] Fusek M.: Mechanické zkoušky v oblasti valivého kontaktu - zkušební zařízení, *In: 6. mezinárodní konference Aplikovaná mechanika*, Bratislava, Slovensko 2004 (v tisku).
- [10] Lenert, J., Frydrýšek, K., Václavek, L., Kučera, J., Halama, R.: Závěrečná zpráva výzkumného záměru č. J17/98: 272 300009, Zvyšování provozní spolehlivosti strojů a strojní zařízení a snižování jejich negativních vlivů na životní prostředí (Dílčí část 8 - Únavová životnost v kontaktní únavě), FS VŠB-TU Ostrava, katedra pružnosti a pevnosti, Ostrava 2002.
- [11] Lenert, J., Fuxa, J., Kučera, J., Václavek, L., Frydrýšek, K., Halama, R., Šárek, L.: Závěrečná zpráva výzkumného záměru č. J17/98: 272 300009, Zvyšování provozní spolehlivosti strojů a strojní zařízení a snižování jejich negativních vlivů na životní prostředí (Dílčí část 7 - Únavová životnost v kontaktní únavě), FS VŠB-TU Ostrava, katedra pružnosti a pevnosti, Ostrava 2002.
- [12] Fuxa, J.: Výzkum kritérií únavové pevnosti kvaziizotropního materiálu namáhaného v podmínkách dvojosého napětového stavu, závěrečná zpráva projektu GAČR 101/99/1245, FS VŠB-TU Ostrava, katedra pružnosti a pevnosti, Ostrava 2001.